

Anchor Stirrers

KPG Anchor-Stirrer (KPG-length 160 mm)

Please indicate desired length **L** when placing your order!

Article No.	Ø KPG mm	Chucking Ø mm	Width B mm	Height H mm
24.603.06	10	8	60	60
24.603.09	10	8	90	90
24.603.11	10	8	110	110
24.603.14	10	8	140	140
24.604.06	16	10	60	60
24.604.09	16	10	90	90
24.604.11	16	10	110	110
24.604.14	16	10	140	140

All stirrers are also available with ZRS instead of KGP
(ZRS-length 300mm).

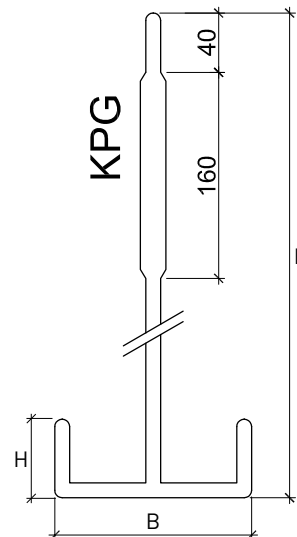

Anchor Stirrer with Simple Glass Shaft

Please indicate desired length **L** when placing your order!

Article No.	Shaft Ø mm	Chucking Ø mm	Width B mm	Height H mm
24.605.06	8	8	60	60
24.605.09	8	8	90	90
24.605.11	8	8	110	110
24.605.14	8	8	140	140
24.606.06	10	10	60	60
24.606.09	10	10	90	90
24.606.11	10	10	110	110
24.606.14	10	10	140	140

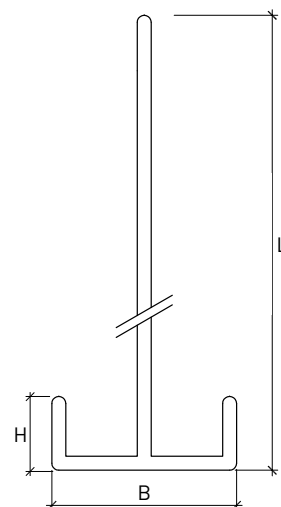

Pretzel Stirrer

KPG Pretzel Stirrer (KPG-Length 160 mm)

Please indicate desired length **L** when placing your order!

Article No.	Ø KPG mm	Chucking Ø mm	Width B mm	Height H mm
24.618.06	10	8	60	55
24.618.09	10	8	90	85
24.618.11	10	8	110	85
24.618.14	10	8	140	100
24.619.06	16	10	60	55
24.619.09	16	10	90	85
24.619.11	16	10	110	85
24.619.14	16	10	140	100

All stirrers are also available with ZRS instead of KGP (ZRS-length 300mm).

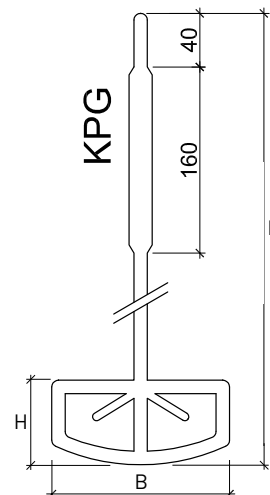

Pretzel Stirrer with Simple Glass Shaft

Please indicate desired length **L** when placing your order!

Article No.	Shaft Ø mm	Chucking Ø mm	Width B mm	Height H mm
24.620.06	8	8	60	55
24.620.09	8	8	90	85
24.620.11	8	8	110	85
24.620.14	8	8	140	100
24.621.06	10	10	60	55
24.621.09	10	10	90	85
24.621.11	10	10	110	85
24.621.14	10	10	140	100

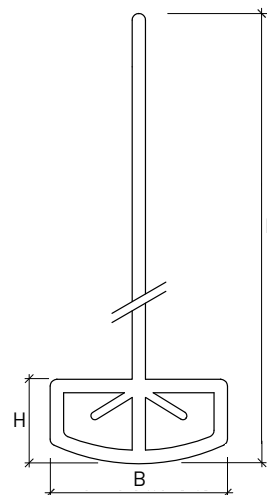

Double Anchor Stirrer

KPG Double anchor stirrer (KPG-Length 160 mm)

Please indicate desired length **L** when placing your order!

Article No.	Ø KPG mm	Chucking Ø mm	Width B mm	Height H mm
24.626.06	10	8	60	60
24.626.09	10	8	90	90
24.626.11	10	8	110	110
24.626.14	10	8	140	140
24.627.06	16	10	60	60
24.627.09	16	10	90	90
24.627.11	16	10	110	110
24.627.14	16	10	140	140

All stirrers are also available with ZRS instead of KGP
(ZRS-length 300mm).

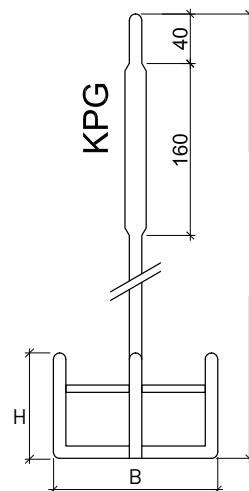

Double Anchor Stirrer with Simple Glass Shaft

Please indicate desired length **L** when placing your order!

Article No.	Shaft Ø mm	Chucking Ø mm	Width B mm	Height H mm
24.628.06	8	8	60	60
24.628.09	8	8	90	90
24.628.11	8	8	110	110
24.628.14	8	8	140	140
24.629.06	10	10	60	60
24.629.09	10	10	90	90
24.629.11	10	10	110	110
24.629.14	10	10	140	140

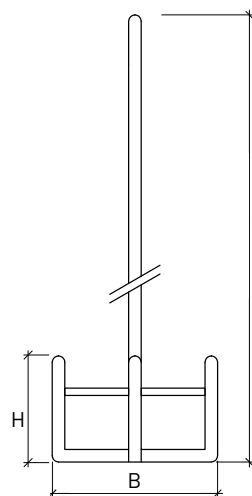

4 Blade Stirrer

KPG 4 Blade Stirrer (KPG Length 160 mm)

Please indicate desired length **L** when placing your order!

Article No.	Ø KPG mm	Chucking Ø mm	Width B mm	Height H mm
24.634.24	10	8	24	25
24.634.40	10	8	40	25
24.634.60	10	8	60	25
24.635.24	16	10	24	25
24.635.40	16	10	40	25
24.635.60	16	10	60	25

All stirrers are also available with ZRS instead of KPG
(ZRS-length 300mm).

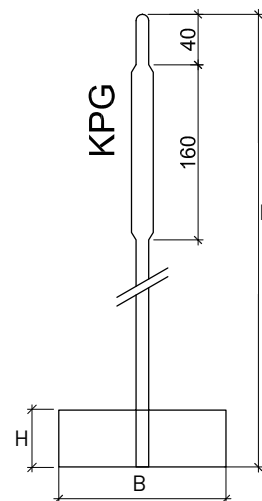

4 Blade Stirrer with Simple Glass Shaft

Please indicate desired length **L** when placing your order!

Article No.	Shaft Ø mm	Chucking Ø mm	Width B mm	Height H mm
24.636.24	8	8	24	25
24.636.40	8	8	40	25
24.636.60	8	8	60	25
24.637.24	10	10	24	25
24.637.40	10	10	40	25
24.637.60	10	10	60	25

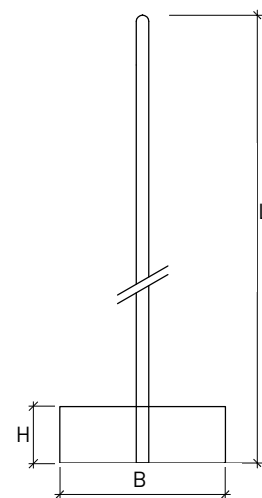

Double 4 Blade Stirrer

KPG Double 4 Blade Stirrer

Please indicate desired length **L** when placing your order!

Article No.	Ø KPG mm	Chucking Ø mm	Width B mm	Height H mm
24.642.24	10	8	24	65
24.642.40	10	8	40	65
24.642.60	10	8	60	65
24.643.24	16	10	24	65
24.643.40	16	10	40	65
24.643.60	16	10	60	65

All stirrers are also available with ZRS instead of KGP (ZRS-length 300mm).

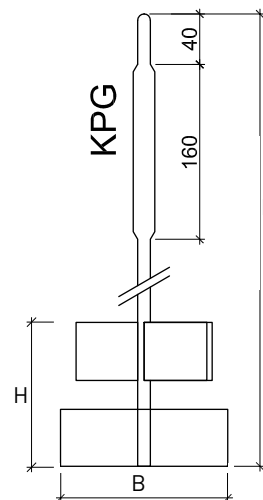

Double 4 Blade Stirrer with Simple Glass Shaft

Please indicate desired length **L** when placing your order!

Article No.	Shaft Ø mm	Chucking Ø mm	Width B mm	Height H mm
24.644.24	8	8	24	65
24.644.40	8	8	40	65
24.644.60	8	8	60	65
24.645.24	10	10	24	65
24.645.40	10	10	40	65
24.645.60	10	10	60	65

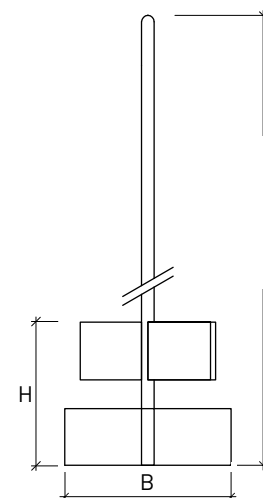

Stirrer Shafts with Eye

for PTFE blades with bolt and straddling stirrer

KPG Stirrer Shaft with Eye (KPG-Length 160 mm)
Please indicate desired length **L** when placing your order!

Article No.	Ø KPG mm	Chucking Ø mm	
23.638.21	10	8	
23.638.24	16	10	

All stirrers are also available with ZRS instead of KGP (ZRS-length 300mm).

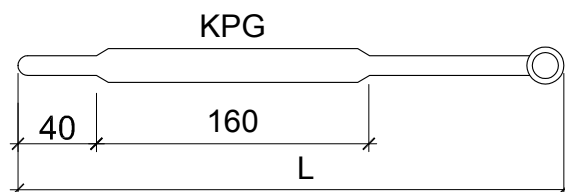

Stirrer shaft with Eye with Simple Glass Shaft
Please indicate desired length **L** when placing your order!

Article No.	Ø shaft mm	Chucking Ø mm	
23.629.08	8	8	
23.629.10	10	10	
23.629.12	12	10	
23.629.14	14	10	
23.629.16	16	10	

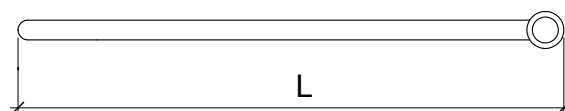

Straddling Stirrer Blade with Bolt
for stirrer shafts with eye, suitable for joints size NS 24 or bigger.

Article No.	Stirring Ø mm	Bolt Ø mm	
23.643.07	50	8	
23.643.09	70	8	
23.643.11	90	8	

Replacement bolts and other sizes on request.
(Available with blade widths 30, 120 and 140 mm, however with different bolt sizes!)

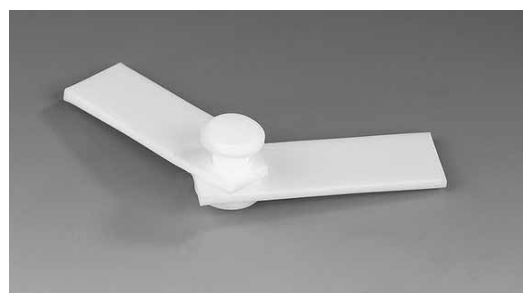

Stirrer Shafts with Double Pivot

for PTFE moon-shaped stirrer blades with double-sided eyelet

KPG Stirrer Blade with Double Pivot (KPG Length 160 mm)

Please indicate desired length **L** when placing your order!

Article No.	Ø KPG mm	Chucking Ø mm	
23.638.01	10	8	
23.638.04	16	10	

All stirrers are also available with ZRS instead of KGP (ZRS-length 300mm).

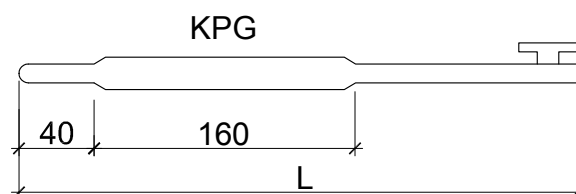

Stirrer Blade with Double Pivot with Simple Glass Shaft

Please indicate desired length **L** when placing your order!

Article No.	Ø Shaft mm	Chucking Ø mm	
23.640.01	10	10	

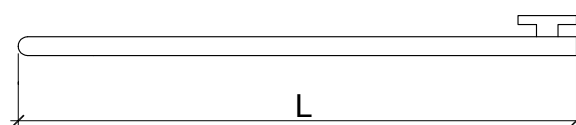

PTFE Moon-Shaped Stirrer Blades with Double-Sided Eyelet

for stirrer shafts with double pivot

Article No.	Stirrer blade mm	fits NS	
23.644.01	50 x 18 x 3	24	
23.644.02	50 x 24 x 3	29	
23.644.04	65 x 18 x 3	24	
23.644.05	68 x 24 x 3	29	
23.644.06	75 x 24 x 3	29	
23.644.07	90 x 24 x 3	29	
23.644.08	110 x 24 x 3	29	
23.644.09	125 x 24 x 3	29	
23.644.10	145 x 35 x 4	45	



Stirrer Shaft with Thread Head

for PTFE stirrer heads with SVL TORION 5 thread

KPG Stirrer Shaft with Thread Head (KPG Length 160 mm)

Please indicate desired length **L** by placing your order!

Article No.	Ø KPG mm	Chucking Ø mm	
23.647.01	10	8	
23.647.04	16	10	

All stirrers are also available with ZRS instead of KGP (ZRS-length 300mm).

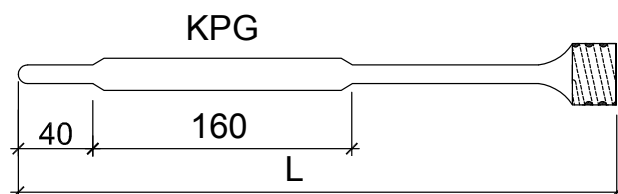

Stirrer Shaft with Thread Head with Simple Glass Shaft

Please indicate desired length **L** by placing your order!

Article No.	Ø Shaft mm	Chucking Ø mm	
23.648.01	10	10	
23.648.02	12	10	
23.648.03	14	10	
23.648.04	16	10	

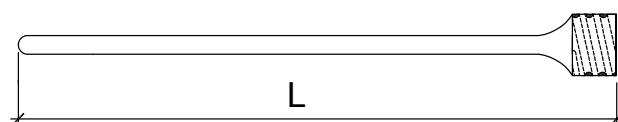

PTFE Stirrer Heads with Thread

fits stirrer shafts with SVL TORION 5 thread

Article No.	Stirrer head type	Wide mm	
23.650.10	Straddling blades (1)	70	
23.650.20	Leaf (2)	70	
23.650.30	Small anchor (3)	54	
23.650.35	Big anchor (4)	90	
23.650.40	Propeller (5)	80	



1



2



3



4



5

Stainless Steel Stirrer

Anchor Stirrer

Article No.	Width B mm	Height H mm	Length L mm	Ø Shaft mm
23.651.01	60	60	800	10
23.651.02	60	60	1000	10
23.651.41	90	90	800	10
23.651.42	90	90	1000	10
23.651.03	110	110	800	10
23.651.04	110	110	1000	10
23.651.05	140	140	800	10
23.651.06	140	140	1000	10
23.651.07	140	140	1200	10
23.651.08	190	190	800	10
23.651.09	190	190	1000	10
23.651.10	190	190	1200	10

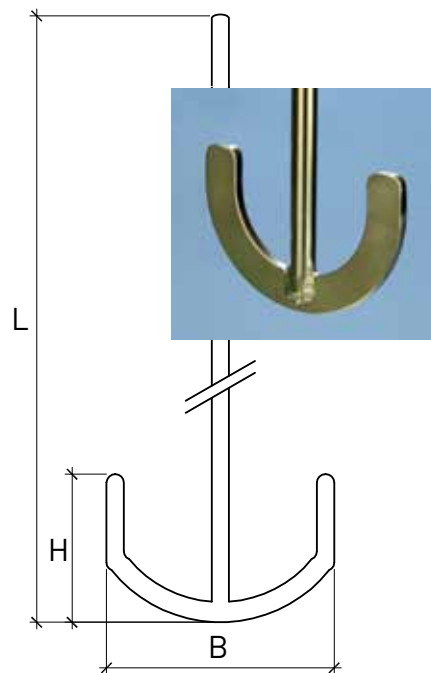

Pretzel-Stirrer

Article No.	Width B mm	Height H mm	Length L mm	Ø Shaft mm
23.651.21	60	60	800	10
23.651.22	60	60	1000	10
23.651.45	90	90	800	10
23.651.46	90	90	1000	10
23.651.23	110	110	800	10
23.651.24	110	110	1000	10
23.651.25	140	140	800	10
23.651.26	140	140	1000	10
23.651.27	140	140	1200	10
23.651.28	190	190	800	10
23.651.29	190	190	1000	10
23.651.30	190	190	1200	10

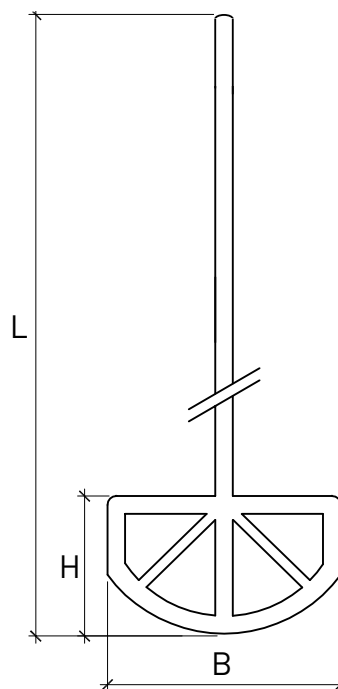

All other forms and sizes by request. Stainless steel stirrer shafts can be coated with HALAR (max. working temperature- 150°C).

BOLA Stirrers Stainless Steel/PFTE

As alternative to glass or stainless steel stirrers, we offer BOLA stirrers. Please find the whole BOLA range on:

<http://www.bola.de/en/products/stirring-and-mixing/stirrer-shafts.html>

BOLA stirrers are made with a PTFE covered stainless steel shaft and blades of PTFE. The steel core provides high stability and allows safe fixing in the stirrer coupling. The product wich is stirred is only exposed to PTFE.

Temperature range: -200°C up to +250°C

Chemical resistance: +++ universal

Example: **Anchor Stirrer**

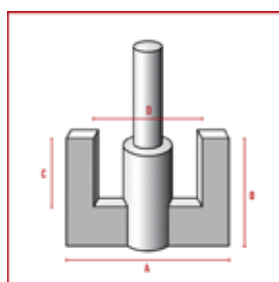

BOLA Stirrer with one Paddle



BOLA Stirrer with two Paddles



BOLA Propeller Stirrer



BOLA Centrifugal Stirrer

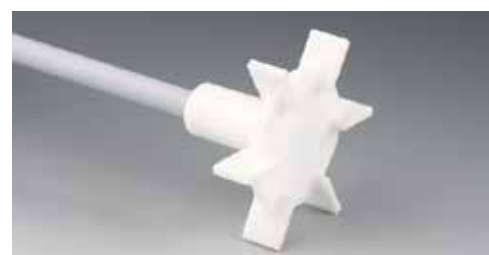

BOLA Disc Stirrer

Article No.	Length mm	Shaft Ø mm	Chucking Ø mm	A mm	B mm	C mm	D mm
C 384-01	350	8	6.5	40	35	20	26
C 384-02	350	8	6.5	60	40	25	30
C 384-04	450	8	6.5	60	40	25	30
C 384-06	450	8	6.5	80	50	30	44
C 384-08	600	8	6.5	80	50	30	44
C 384-10	600	8	6.5	100	60	35	56
C 384-16	350	10	8	80	50	30	44
C 384-17	450	10	8	80	50	30	44
C 384-24	600	10	8	100	60	35	56
C 384-28	800	10	8	100	60	35	56
C 384-32	1000	10	8	100	60	35	56
C 384-40	1200	10	8	100	60	35	56
C 384-44	600	10	8	130	80	55	80
C 384-48	800	16	8	130	80	55	80
C 584-52	800	16	10	150	120	90	90
C 584-58	1000	16	10	150	120	90	90
C 584-64	1200	16	10	150	120	90	90